







whisperwool<sup>®</sup>  
wall panels

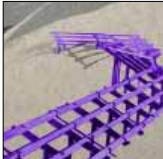

**Inhalt**  
*content*

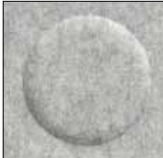
	<b>Oblong</b>	glatt / sleek	4
		gewellt / wavy	5
		Art	8
	<b>Diva</b>	glatt / sleek	14
		gewellt / wavy	15
	<b>Apps</b>	.....	18
	<b>Honey</b>	.....	19
	<b>Moss</b>	.....	20
	<b>Daten</b>	<i>data</i>	22
	<b>Impressum</b>	<i>imprint</i>	23

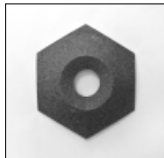
**Wandpaneele**  
*wall panels*

**Oblong glatt**

Whisperwool auf Holzfaserrahmen  
hinterdämmt mit Schafwolle  
Montageplatten für Hängemontage

*Whisperwool mounted on a  
wooden frame with insulation  
mounting plates*

Brandklasse  
Absorption  $\alpha_w$   
Absorberklasse

F *flame resistance*  
0,35 *absorption  $\alpha_w$*   
D *absorption class*

F  
0,35  
D

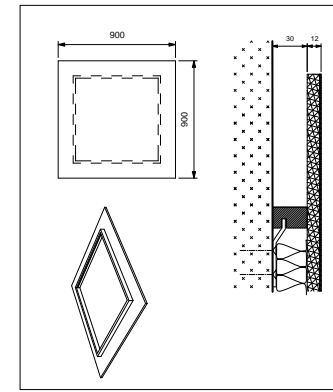

**Wandpaneele**  
*wall panels*

**Oblong gewellt**



**Wandschaf Oblong Naturweiß**

Breite	90 cm
Höhe	90 cm
Aufbauhöhe	4,2 cm
Artikelnummer	W2G018

**Wall Sheep Oblong Natural White**

<i>width</i>	<i>90 cm</i>
<i>height</i>	<i>90 cm</i>
<i>structural height</i>	<i>4,2 cm</i>
<i>article number</i>	<i>W2G018</i>



**Wandschaf Oblong Silbergrau**

Breite	90 cm
Höhe	90 cm
Aufbauhöhe	4,2 cm
Artikelnummer	W2G518

**Wall Sheep Oblong Silvergrey**

<i>width</i>	<i>90 cm</i>
<i>height</i>	<i>90 cm</i>
<i>structural height</i>	<i>4,2 cm</i>
<i>article number</i>	<i>W2G518</i>



**Wandschaf Oblong Anthrazit**

Breite	90 cm
Höhe	90 cm
Aufbauhöhe	4,2 cm
Artikelnummer	W2G818

**Wall Sheep Oblong Anthracite**

<i>width</i>	<i>90 cm</i>
<i>height</i>	<i>90 cm</i>
<i>structural height</i>	<i>4,2 cm</i>
<i>article number</i>	<i>W2G818</i>



**Wandschaf Oblong Naturweiß  
Fleur de Lis**

Breite	90 cm
Höhe	90 cm
Aufbauhöhe	4,7 cm
Artikelnummer	W2S003G018

**Wall Sheep Oblong Natural White  
Fleur de Lis**

<i>width</i>	<i>90 cm</i>
<i>height</i>	<i>90 cm</i>
<i>structural height</i>	<i>4,7 cm</i>
<i>article number</i>	<i>W2S003G018</i>

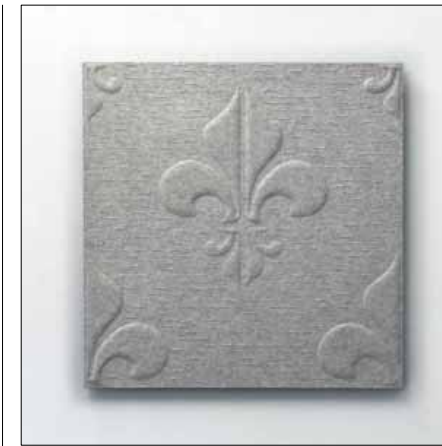

**Wandschaf Oblong Silbergrau  
Fleur de Lis**

Breite	90 cm
Höhe	90 cm
Aufbauhöhe	4,7cm
Artikelnummer	W2S003G518

**Wall Sheep Oblong Silvergrey  
Fleur de Lis**

<i>width</i>	<i>90 cm</i>
<i>height</i>	<i>90 cm</i>
<i>structural height</i>	<i>4,7 cm</i>
<i>article number</i>	<i>W2S003G518</i>



**Wandschaf Oblong Naturweiß  
Dots**

Breite	90 cm
Höhe	90 cm
Aufbauhöhe	4,7cm
Artikelnummer	W2S004G018

**Wall Sheep Oblong Natural White  
Dots**

<i>width</i>	<i>90 cm</i>
<i>height</i>	<i>90 cm</i>
<i>structural height</i>	<i>4,7 cm</i>
<i>article number</i>	<i>W2S004G018</i>

**Wandpaneele**  
*wall panels*

**Oblong gewellt**

Whisperwool auf Holzfaserrahmen  
hinterdämmt mit Schafwolle  
Montageplatten für Hängemontage

*Whisperwool mounted on a  
wooden frame with insulation  
mounting plates*

Brandklasse	F	<i>flame resistance</i>	F
Absorption $\alpha_w$	0,35	<i>absorption <math>\alpha_w</math></i>	0,35
Absorberklasse	D	<i>absorption class</i>	D

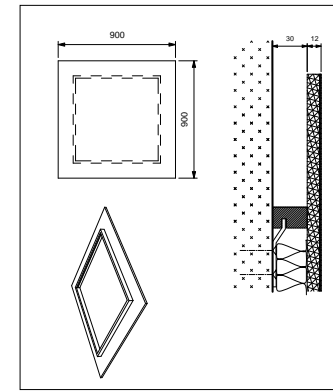

**Wandpaneele**  
*wall panels*

**Oblong gewellt**



**Wandschaf Oblong Silbergrau  
Dots**

Breite	90 cm
Höhe	90 cm
Aufbauhöhe	4,7 cm
Artikelnummer	W2S004G518

**Wall Sheep Oblong Silvergrey  
Dots**

<i>width</i>	<i>90 cm</i>
<i>height</i>	<i>90 cm</i>
<i>structural height</i>	<i>4,7 cm</i>
<i>article number</i>	<i>W2S004G518</i>



**Wandschaf Oblong Naturweiß  
Nickel**

Breite	90 cm
Höhe	90 cm
Aufbauhöhe	4,7cm
Artikelnummer	W2S005G018

**Wall Sheep Oblong Natural White  
Nickel**

<i>width</i>	<i>90 cm</i>
<i>height</i>	<i>90 cm</i>
<i>structural height</i>	<i>4,7 cm</i>
<i>article number</i>	<i>W2S005G018</i>

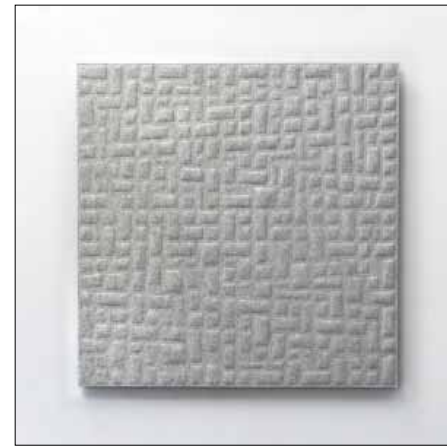

**Wandschaf Oblong Silbergrau  
Nickel**

Breite	90 cm
Höhe	90 cm
Aufbauhöhe	4,7cm
Artikelnummer	W2S005G518

**Wall Sheep Oblong Silvergrey  
Nickel**

<i>width</i>	<i>90 cm</i>
<i>height</i>	<i>90 cm</i>
<i>structural height</i>	<i>4,7 cm</i>
<i>article number</i>	<i>W2S005G518</i>



**Wandschaf Oblong Naturweiß  
Polka**

Breite	90 cm
Höhe	90 cm
Aufbauhöhe	4,7 cm
Artikelnummer	W2S006G018

**Wall Sheep Oblong Natural White  
Polka**

<i>width</i>	<i>90 cm</i>
<i>height</i>	<i>90 cm</i>
<i>structural height</i>	<i>4,7 cm</i>
<i>article number</i>	<i>W2S006G018</i>



**Wandschaf Oblong Silbergrau  
Polka**

Breite	90 cm
Höhe	90 cm
Aufbauhöhe	4,7cm
Artikelnummer	W2S006G518

**Wall Sheep Oblong Silvergrey  
Polka**

<i>width</i>	<i>90 cm</i>
<i>height</i>	<i>90 cm</i>
<i>structural height</i>	<i>4,7 cm</i>
<i>article number</i>	<i>W2S006G518</i>

**Wandpaneele**  
*wall panels*

**Oblong Art**

Whisperwool auf Holzfaserrahmen  
hinterdämmt mit Schafwolle  
Montageplatten für Hängemontage

Whisperwool mounted on a  
wooden frame with insulation  
mounting plates

Brandklasse	F	<i>flame resistance</i>	F
Absorption $\alpha_w$	0,35	<i>absorption <math>\alpha_w</math></i>	0,35
Absorberklasse	D	<i>absorption class</i>	D

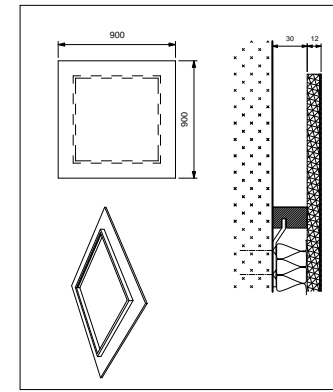

**Wandpaneele**  
*wall panels*

**Oblong Art**



**Wandschaf Oblong Naturweiß Franz**

Breite	90 cm
Höhe	90 cm
Aufbauhöhe	4,2 cm
Artikelnummer	W2P001G019

**Wall Sheep Oblong Natural White Franz**

<i>width</i>	90 cm
<i>height</i>	90 cm
<i>structural height</i>	4,2 cm
<i>article number</i>	W2P001G019

Artist: Markus Bstieler

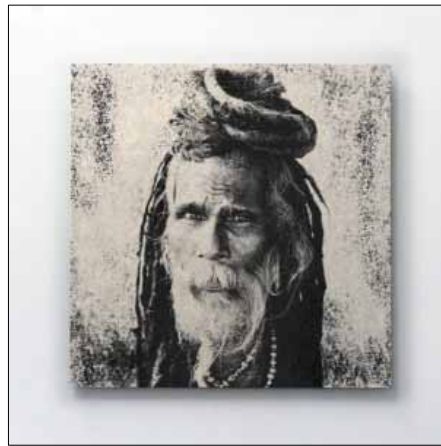

**Wandschaf Oblong Naturweiß Sadhu**

Breite	90 cm
Höhe	90 cm
Aufbauhöhe	4,2 cm
Artikelnummer	W2P002G019

**Wall Sheep Oblong Natural White Sadhu**

<i>width</i>	90 cm
<i>height</i>	90 cm
<i>structural height</i>	4,2 cm
<i>article number</i>	W2P001G019

Artist: Dietmar Temps



**Wandschaf Oblong Naturweiß Margarit**

Breite	90 cm
Höhe	90 cm
Aufbauhöhe	4,2 cm
Artikelnummer	W2P003G019

**Wall Sheep Oblong Natural White Margarit**

<i>width</i>	90 cm
<i>height</i>	90 cm
<i>structural height</i>	4,2 cm
<i>article number</i>	W2P003G019

Artist: PPhilipp



**Wandschaf Oblong Naturweiß Lake**

Breite	90 cm
Höhe	90 cm
Aufbauhöhe	4,2 cm
Artikelnummer	W2P004G019

**Wall Sheep Oblong Natural White Lake**

<i>width</i>	90 cm
<i>height</i>	90 cm
<i>structural height</i>	4,2 cm
<i>article number</i>	W2P004G019

Artist: PPhilipp



**Wandschaf Oblong Naturweiß Kalkkögl**

Breite	90 cm
Höhe	90 cm
Aufbauhöhe	4,2 cm
Artikelnummer	W2P005G019

**Wall Sheep Oblong Natural White Kalkkögl**

<i>width</i>	90 cm
<i>height</i>	90 cm
<i>structural height</i>	4,2 cm
<i>article number</i>	W2P005G019

Artist: PPhilipp



**Wandschaf Oblong Naturweiß Corvette**

Breite	90 cm
Höhe	90 cm
Aufbauhöhe	4,2 cm
Artikelnummer	W2P006G019

**Wall Sheep Oblong Natural White Corvette**

<i>width</i>	90 cm
<i>height</i>	90 cm
<i>structural height</i>	4,2 cm
<i>article number</i>	W2P006G019

Artist: PPhilipp

**Wandpaneele**  
*wall panels*

**Oblong Art**

Whisperwool auf Holzfaserrahmen  
hinterdämmt mit Schafwolle  
Montageplatten für Hängemontage

Whisperwool mounted on a  
wooden frame with insulation  
mounting plates

Brandklasse	F	flame resistance	F
Absorption $\alpha_w$	0,35	absorption $\alpha_w$	0,35
Absorberklasse	D	absorption class	D

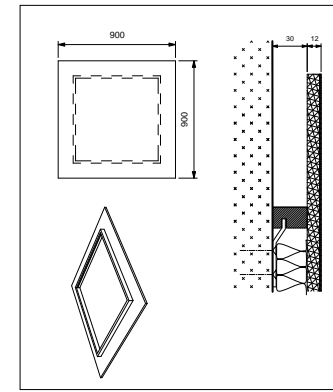

**Wandpaneele**  
*wall panels*

**Oblong Art**



**Wandschaf Oblong Naturweiß**  
**Lotte**

Breite	90 cm
Höhe	90 cm
Aufbauhöhe	4,2 cm
Artikelnummer	W2P007G019

**Wall Sheep Oblong Natural White**  
**Lotte**

width	90 cm
height	90 cm
structural height	4,2 cm
article number	W2P007G019

Artist: PPhilipp



**Wandschaf Oblong Naturweiß**  
**Europabrücke**

Breite	90 cm
Höhe	90 cm
Aufbauhöhe	4,2 cm
Artikelnummer	W2P008G019

**Wall Sheep Oblong Natural White**  
**Europabrücke**

width	90 cm
height	90 cm
structural height	4,2 cm
article number	W2P008G019

Artist: Roland Maurmair



**Wandschaf Oblong Naturweiß**  
**Lawine**

Breite	90 cm
Höhe	90 cm
Aufbauhöhe	4,2 cm
Artikelnummer	W2P009G019

**Wall Sheep Oblong Natural White**  
**Lawine**

width	90 cm
height	90 cm
structural height	4,2 cm
article number	W2P009G019

Artist: Roland Maurmair



**Wandschaf Oblong Naturweiß**  
**Stadl**

Breite	90 cm
Höhe	90 cm
Aufbauhöhe	4,2 cm
Artikelnummer	W2P010G019

**Wall Sheep Oblong Natural White**  
**Stadl**

width	90 cm
height	90 cm
structural height	4,2 cm
article number	W2P010G019

Artist: Roland Maurmair



**Wandschaf Oblong Naturweiß**  
**Alm**

Breite	90 cm
Höhe	90 cm
Aufbauhöhe	4,2 cm
Artikelnummer	W2P011G019

**Wall Sheep Oblong Natural White**  
**Alm**

width	90 cm
height	90 cm
structural height	4,2 cm
article number	W2P011G019

Artist: Roland Maurmair



**Wandschaf Oblong Naturweiß**  
**Kalbl**

Breite	90 cm
Höhe	90 cm
Aufbauhöhe	4,2 cm
Artikelnummer	W2P012G019

**Wall Sheep Oblong Natural White**  
**Kalbl**

width	90 cm
height	90 cm
structural height	4,2 cm
article number	W2P012G019

Artist: Roland Maurmair

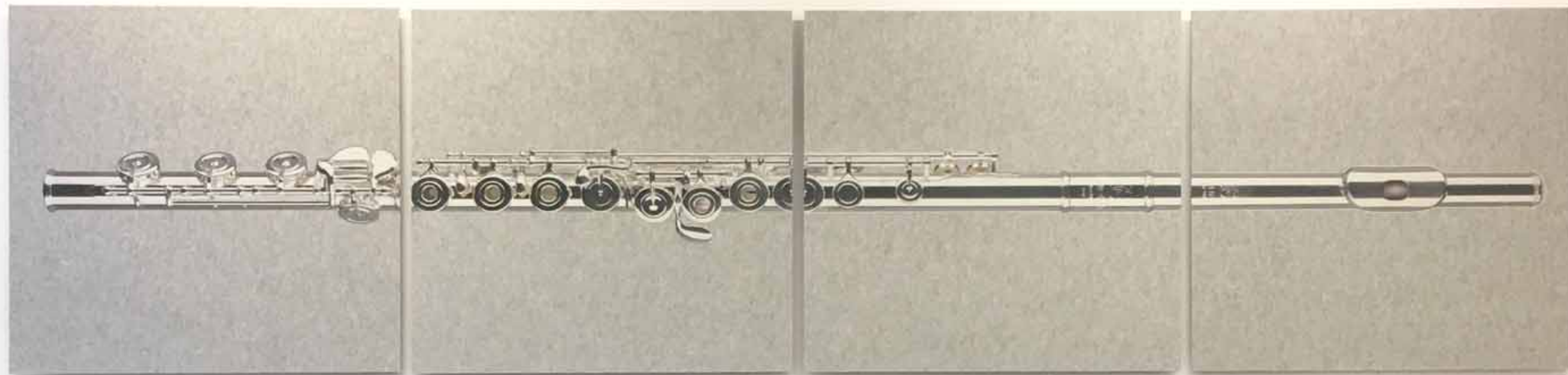

**Wandpaneele**  
*wall panels*

**Diva**

Whisperwool in zartem Eschen-  
rahmen geölt  
hinterdämmt mit Schafwolle  
Montageplatten für Hängemontage

Brandklasse  
Absorption  $\alpha_w$   
Absorberklasse

F *flame resistance*  
0,9 *absorption  $\alpha_w$*   
A *absorption class*

F  
0,9  
A

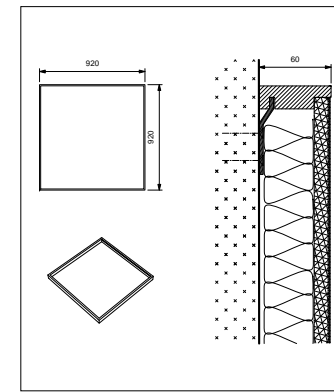

**Wandpaneele**  
*wall panels*

**Diva**



**Wandschaf Diva Naturweiß**

Breite	92 cm
Höhe	92 cm
Aufbauhöhe	6 cm
Artikelnummer	W3G018

**Wall Sheep Diva Natural White**

<i>width</i>	92 cm
<i>height</i>	92 cm
<i>structural height</i>	6 cm
<i>article number</i>	W3G018



**Wandschaf Diva Silbergrau**

Breite	92 cm
Höhe	92 cm
Aufbauhöhe	6 cm
Artikelnummer	W3G518

**Wall Sheep Diva Silvergrey**

<i>width</i>	92 cm
<i>height</i>	92 cm
<i>structural height</i>	6 cm
<i>article number</i>	W3G518



**Wandschaf Diva Anthrazit**

Breite	92 cm
Höhe	92 cm
Aufbauhöhe	6 cm
Artikelnummer	W3G818

**Wall Sheep Diva Anthracite**

<i>width</i>	92 cm
<i>height</i>	92 cm
<i>structural height</i>	6 cm
<i>article number</i>	W3G818



**Wandschaf Diva Naturweiß  
Fleur de Lis**

Breite	92 cm
Höhe	92 cm
Aufbauhöhe	6,5 cm
Artikelnummer	W3S003G018

**Wall Sheep Diva Natural White  
Fleur de Lis**

<i>width</i>	92 cm
<i>height</i>	92 cm
<i>structural height</i>	6,5 cm
<i>article number</i>	W3S003G018



**Wandschaf Diva Silbergrau  
Fleur de Lis**

Breite	92 cm
Höhe	92 cm
Aufbauhöhe	6,5 cm
Artikelnummer	W3S003G518

**Wall Sheep Diva Silvergrey  
Fleur de Lis**

<i>width</i>	92 cm
<i>height</i>	92 cm
<i>structural height</i>	6,5 cm
<i>article number</i>	W3S003G518



**Wandschaf Diva Naturweiß  
Dots**

Breite	92 cm
Höhe	92 cm
Aufbauhöhe	6,5 cm
Artikelnummer	W3S004G018

**Wall Sheep Diva Natural White  
Dots**

<i>width</i>	92 cm
<i>height</i>	92 cm
<i>structural height</i>	6,5 cm
<i>article number</i>	W3S004G018



**Wandpaneele**  
*wall panels*

**Diva**

Whisperwool in zartem Eschenrahmen geölt  
hinterdämmt mit Schafwolle  
Montageplatten für Hängemontage

Brandklasse  
Absorption  $\alpha_w$   
Absorberklasse

*F* *flame resistance*  
*0,9* *absorption  $\alpha_w$*   
*A* *absorption class*

*F*  
*0,9*  
*A*

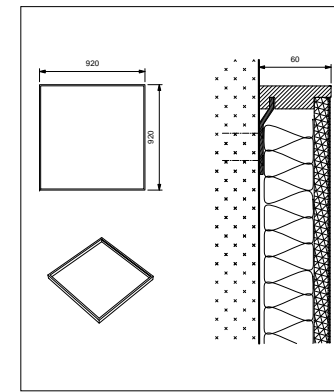

**Wandpaneele**  
*wall panels*

**Diva**



**Wandschaf Diva Silbergrau**  
**Dots**

Breite	92 cm
Höhe	92 cm
Aufbauhöhe	6,5 cm
Artikelnummer	W3S004G518

**Wall Sheep Diva Silvergrey**  
**Dots**

<i>width</i>	<i>92 cm</i>
<i>height</i>	<i>92 cm</i>
<i>structural height</i>	<i>6,5 cm</i>
<i>article number</i>	<i>W3S004G518</i>



**Wandschaf Diva Naturweiß**  
**Nickel**

Breite	92 cm
Höhe	92 cm
Aufbauhöhe	6,5 cm
Artikelnummer	W3S005G018

**Wall Sheep Diva Silvergrey**  
**Nickel**

<i>width</i>	<i>92 cm</i>
<i>height</i>	<i>92 cm</i>
<i>structural height</i>	<i>6,5 cm</i>
<i>article number</i>	<i>W3S005G018</i>



**Wandschaf Diva Silbergrau**  
**Nickel**

Breite	92 cm
Höhe	92 cm
Aufbauhöhe	6,5 cm
Artikelnummer	W3S005G518

**Wall Sheep Diva Natural White**  
**Nickel**

<i>wide</i>	<i>92 cm</i>
<i>width</i>	<i>92 cm</i>
<i>structural height</i>	<i>6,5 cm</i>
<i>article number</i>	<i>W3S005G518</i>



**Wandschaf Diva Naturweiß**  
**Polka**

Breite	92 cm
Höhe	92 cm
Aufbauhöhe	6,5 cm
Artikelnummer	W3S006G018

**Wall Sheep Diva Natural White**  
**Polka**

<i>width</i>	<i>92 cm</i>
<i>height</i>	<i>92 cm</i>
<i>structural height</i>	<i>6,5 cm</i>
<i>article number</i>	<i>W3S006G018</i>



**Wandschaf Diva Silbergrau**  
**Polka**

Breite	92 cm
Höhe	92 cm
Aufbauhöhe	6,5 cm
Artikelnummer	W3S006G518

**Wall Sheep Diva Silvergrey**  
**Polka**

<i>width</i>	<i>92 cm</i>
<i>height</i>	<i>92 cm</i>
<i>structural height</i>	<i>6,5 cm</i>
<i>article number</i>	<i>W3S006G518</i>

**Wandpaneele**  
*wall panels*

**Apps**

Whisperwool auf Holzfaserrahmen  
hinterdämmt mit Schafwolle  
Montageplatten für Hängemontage

Brandklasse *F*  
Absorption  $\alpha_w$  0,9  
Absorberklasse *A*

*Whisperwool mounted on a  
wooden frame with insulation  
mounting plates*

*flame resistance* *F*  
*absorption  $\alpha_w$*  0,9  
*absorption class* *A*

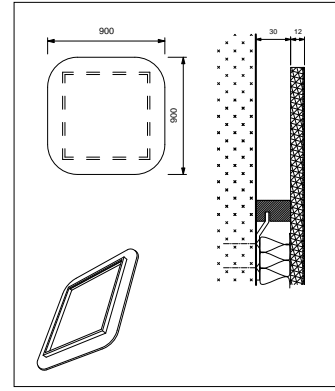

**Wandschaf Apps Naturweiß**

Breite 90 cm  
Höhe 90 cm  
Aufbauhöhe 4,2 cm  
Artikelnummer W2F001G019

**Wandschaf Apps Silbergrau**

Breite 90 cm  
Höhe 90 cm  
Aufbauhöhe 4,2 cm  
Artikelnummer W2F001G519

**Wandschaf Apps Naturweiß**

Breite 90 cm  
Höhe 90 cm  
Aufbauhöhe 4,2cm  
Artikelnummer W2F001G819

**Wall Sheep Apps Natural White**

*width* 90 cm  
*height* 90 cm  
*structural height* 4,2 cm  
*article number* W2F001G019

**Wall Sheep Apps Silvergrey**

*width* 90 cm  
*height* 90 cm  
*structural height* 4,2 cm  
*article number* W2F001G519

**Wall Sheep Apps Anthracite**

*width* 90 cm  
*height* 90 cm  
*structural height* 4,2 cm  
*article number* W2F001G819

Whisperwool gefaltet,  
Montage mittels Magneten

Brandklasse *F*  
Absorption  $\alpha_w$  0,35/0,75  
Absorberklasse *B/C*

*Whisperwool folded,  
installation with magnets*

*flame resistance* *F*  
*absorption  $\alpha_w$*  0,35/0,75  
*absorption class* *B/C*

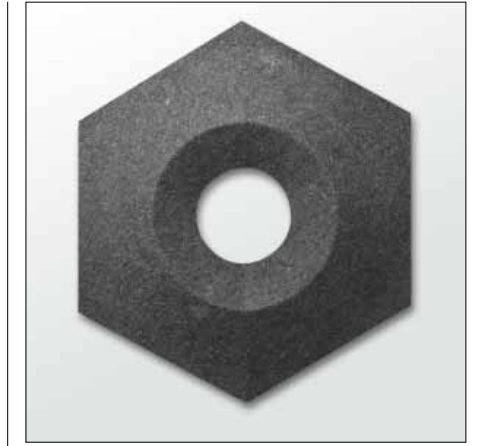
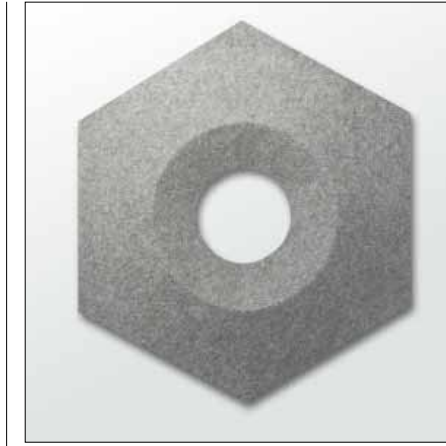
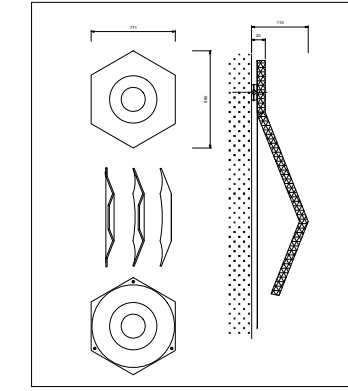

**Wandschaf Honey Naturweiß**

Breite 77 cm  
Höhe 98 cm  
Aufbauhöhe 11 cm  
Artikelnummer W4S007G019

**Wandschaf Honey Silbergrau**

Breite 77 cm  
Höhe 98 cm  
Aufbauhöhe 11 cm  
Artikelnummer W4S007G519

**Wandschaf Honey Anthrazit**

Breite 77 cm  
Höhe 98 cm  
Aufbauhöhe 11 cm  
Artikelnummer W4S007G819

**Wall Sheep Honey Natural White**

*width* 77 cm  
*height* 98 cm  
*structural height* 11 cm  
*article number* W4S007G019

**Wall Sheep Honey Silvergrey**

*width* 77 cm  
*height* 98 cm  
*structural height* 11 cm  
*article number* W4S007G519

**Wall Sheep Honey Anthracite**

*width* 77 cm  
*height* 98 cm  
*structural height* 11 cm  
*article number* W4S007G819

**Wandpaneele**  
*wall panels*

**Honey**

**Wandpaneele**  
*wall panels*

**Moss**

Whisperwool auf Holzfaserrahmen  
hinterdämmt mit Schafwolle  
Montageplatten für Hängemontage

Brandklasse *F*  
Absorption  $\alpha_w$  0,9  
Absorberklasse *A*

*Whisperwool mounted on a  
wooden frame with insulation  
mounting plates*

*flame resistance* *F*  
*absorption  $\alpha_w$*  0,9  
*absorption class* *A*

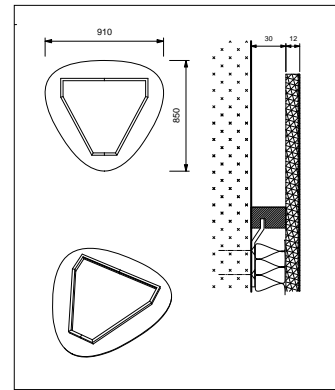

**Wandschaf Moss Naturweiß**

Breite 91 cm  
Höhe 85 cm  
Aufbauhöhe 4,2 cm  
Artikelnummer W2F002G019

**Wandschaf Moss Silbergrau**

Breite 91 cm  
Höhe 87 cm  
Aufbauhöhe 4,2 cm  
Artikelnummer W2F002G519

**Wandschaf Moss Naturweiß**

Breite 91 cm  
Höhe 87 cm  
Aufbauhöhe 4,2 cm  
Artikelnummer W2F002G819

**Wall Sheep Moss Natural White**

width 91 cm  
height 85 cm  
structural height 4,2 cm  
article number W2F002G019

**Wall Sheep Moss Silvergrey**

width 91 cm  
height 85 cm  
structural height 4,2 cm  
article number W2F002G519

**Wall Sheep Moss Anthracite**

width 91 cm  
height 85 cm  
structural height 4,2 cm  
article number W2F002G819

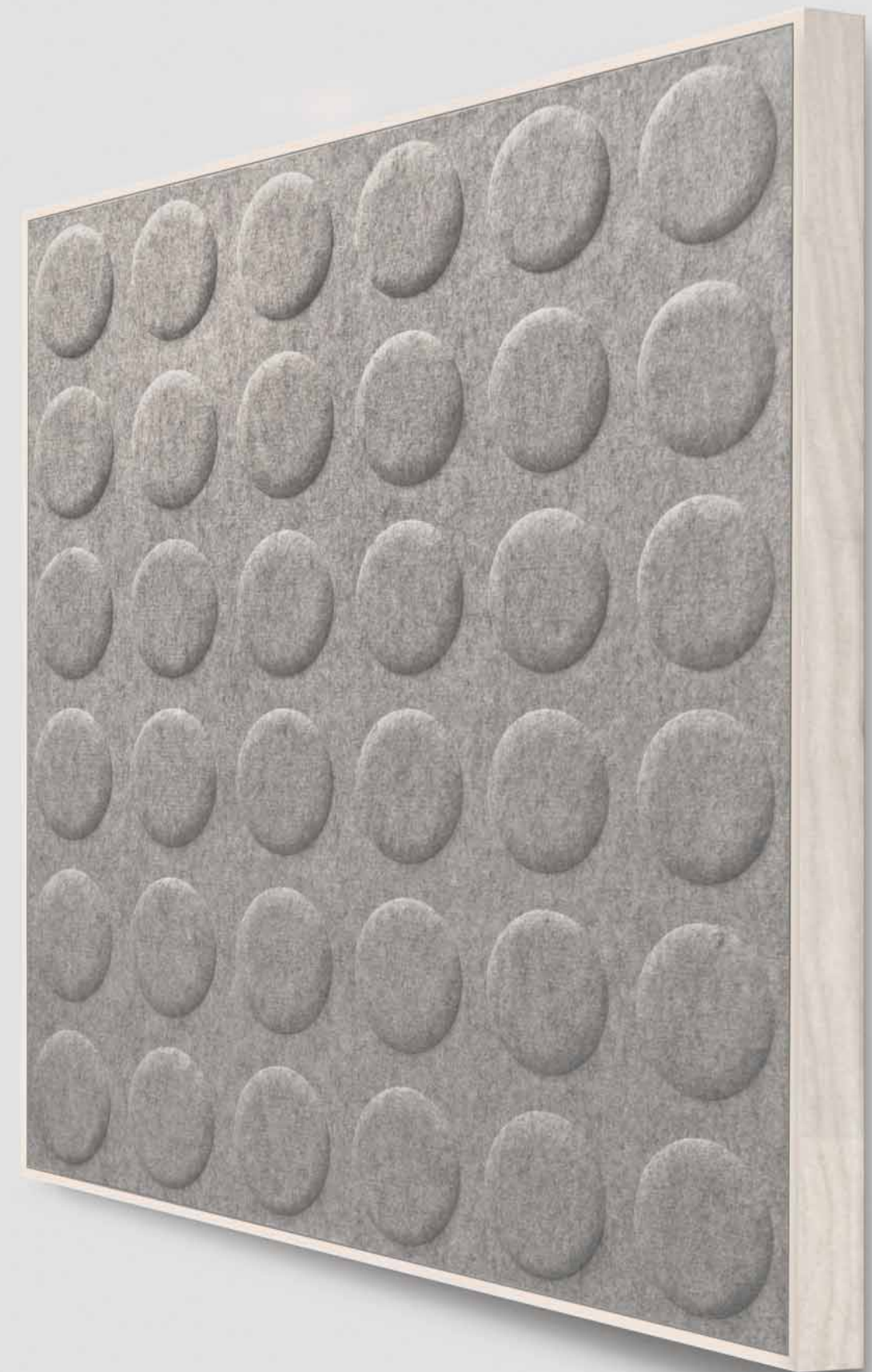

## Daten data

## Absorptionsgrade sound absorption

Whisperwool Akustiklösungen sind hoch schallabsorbierend ab einer Frequenzen von 100 Herz (tiefer wurde nicht erfasst). Der Wandabstand erhöht die Absorption in den tiefen Frequenzen. Mit Hinterdämmung kann der Effekt verstärkt werden. Raumakustik ist ein hochkomplexes Thema. Jeder Raum ist unterschiedlich und hat unterschiedliche Anforderungen. Hier finden sie einen Akustiksimulator, der Ihnen hilft, die Menge an Paneelen zu ermitteln: [www.frischeis.at/web-acoustics](http://www.frischeis.at/web-acoustics)  
Hier können sie auch den Hall eines Raumes vor und nach der Dämmung simulieren, um den gewünschten Raumklang zu erzielen. Whisperwool sind hochwertige Designprodukte, dafür entwickelt mit modernen Wohnmaterialien zu harmonisieren. Man hängt sie daher auch gerne genau an die richtige Stelle, nämlich dort wo die erste Reflexion entsteht.

*Whisperwool Acoustic panels are highly sound absorbing from a frequency of 100 Hz (there was no measurement below). Distance to the wall is influencing the absorption in the lower ranges, also damping does improve the effect. Acoustics in rooms is a very complex subject. Every room is different, and has differing requirements and goals. Find an simulation and calculation tool to help finding the right amount of panels for your room here: [www.frischeis.at/web-acoustics](http://www.frischeis.at/web-acoustics) You can also simulate the reverb before and after damping. Whisperwool are design objects, made to hang them perfectly on the right spot to reduce the first reverb.*

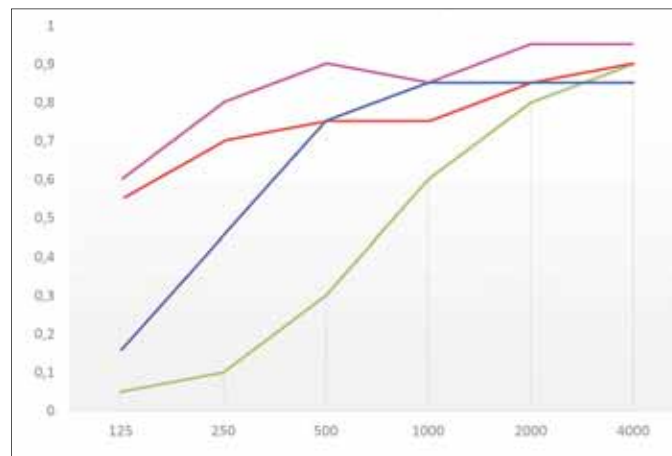

(ÖNORM EN ISO 11654)

— direkt an die Wand  $\alpha_w = 0,35$  Absorberklasse D  
— Wandabstand: 50 mm  $\alpha_w = 0,75$  Absorberklasse C  
— Wandabstand: 50 mm bedämpft  $\alpha_w = 0,90$  Absorberklasse A  
— Wandabstand: 250 mm  $\alpha_w = 0,80$  Absorberklasse B

f [Hz]	100	125	160	200	250	315	400	500	630	800	1000	1250	1600	2000	2500	3150	4000	5000	
Aufbau 1 direkt aufgelegt	0,07	0,07	0,05	0,03	0,10	0,14	0,22	0,28	0,38	0,49	0,57	0,68	0,76	0,80	0,87	0,93	0,89	0,86	0,86
Aufbau 2 - Hohlraum 50 mm, unbedämpft	0,15	0,15	0,20	0,10	0,20	0,23	0,22	0,28	0,38	0,49	0,57	0,68	0,76	0,80	0,87	0,93	0,89	0,86	0,86
Aufbau 3 - Hohlraum 50 mm, voll bedämpft	0,60	0,66	0,53	0,23	0,23	0,23	0,22	0,28	0,38	0,49	0,57	0,68	0,76	0,80	0,87	0,93	0,89	0,86	0,86
Aufbau 4 - Hohlraum 250 mm, unbedämpft	0,64	0,66	0,53	0,23	0,23	0,23	0,22	0,28	0,38	0,49	0,57	0,68	0,76	0,80	0,87	0,93	0,89	0,86	0,86

## Eigenschaften characteristics

- Verbessern die Nachhallzeit,  $\alpha_w$ : bis 0,9
- Raumklimaregulierend (Luftfeuchte)
- filtern Giftstoffe (Formaldehyd) aus der Raumluft
- allergiefrei, mottengeschützt
- schmutzabweisend
- 100% recyclingfähig (cradle to cradle)
- auf Anfrage schwer entflammbar lieferbar
- Material: Tiroler Schafwolle, recycelte Whisperwool und Binfaser (recyceltes PET oder PLA)

- *sound absorption: aw up to 0,9*
- *room climate: adjusts air humidity*
- *cleans and filters formaldehyde out of the air*
- *stain-resistant and self-cleaning*
- *non-allergenic and bactericidal, moth-resistant*
- *on request flame retardant*
- *material: Tirolean sheep's wool, recycled whisperwool and a binding fiber (recycled PET or PLA)*



Das ist Franz. Franz beweidet die Öztaler Hochweiden.

Die Öztaler Hochweiden sind schön, und das auch dank Franz. Denn Franz und seine Vorfahren grasen hier schon seit Jahrhunderten. Franz mag die schnellwachsenden Gräser, dadurch bekommen die Bodendecker und Alpenrosen Licht und Dünger und der Boden wird gefestigt. Das schützt vor Lawinen und Murenabgängen und fördert die Vielfalt an Pflanzen und Tieren.

Deshalb sind die Hochalpen so schön.

Geschoren wird Franz zweimal jährlich, seine Wolle ist rauh wie die Alpen, zu grob für Gewand, aber perfekt für Whisperwool. Ungenutzte Wolle aus Tirol und dem Alpenraum bekommt bei uns wieder eine Anwendung und alle freuen sich: Franz, die Schafbauern, die Berge, Tante Lotte Design und jetzt auch Sie, die gesunde, lärmberuhigte Räume genießen dürfen.



*This is Franz. Franz grazes on the meadows high above the Öztal valley in Tyrol.*

*These alpine meadows are beautiful - thanks in part to Franz. Franz and his ancestors have been grazing here for hundreds of years. Sheep eat the fast-growing grasses, exposing the ground cover plants and alpine roses to light and providing them with fertiliser. This helps to prevent avalanches and landslides and also encourages diversity in the flora and fauna.*

*This is why the high alps are so lovely.*

**Fordern Sie unsere Produktkataloge an,  
oder laden Sie sie herunter  
get our catalogues**

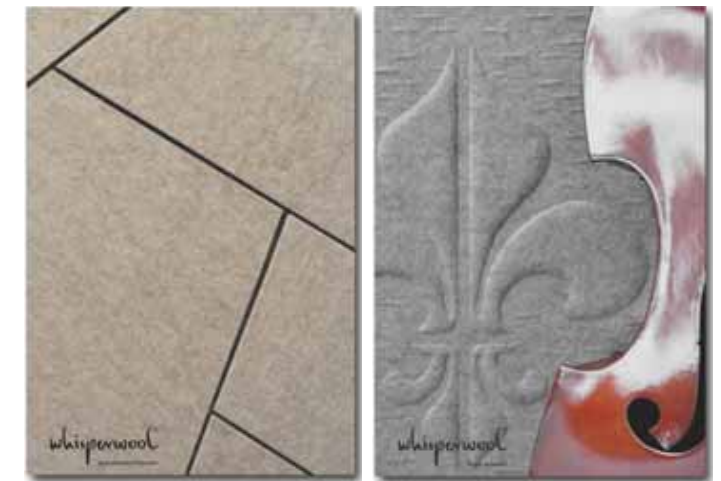

**Impressum  
Information  
imprint**

Tante Lotte Design GmbH  
Höttinger Au 44  
6020 Innsbruck  
Austria  
+43/512/283037  
info@tantelotte.at  
www.whisperwool.at



winner ecology.

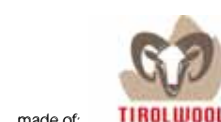

Tante Lotte Design GmbH  
Höttinger Au 44  
6020 Innsbruck  
Austria  
+43/512/283037  
info@tantelotte.at  
www.whisperwool.at

